

COED 8/10 - ROUND ROBIN

Pool A				Won	Lost
1 KEAUKAHA CUZINS COED 10 (1)					
2 PIOPIO BEARS 10 - YOSH					
3 PANAWEA					
4 MILOLII-KAU COED 8					
5 HAILI PINK					
1-5	2-3	1-4	3-5	2-4	1-3
4-5	1-2	3-4	2-5		

Pool B				Won	Lost
1 MILOLII-KAU COED 10					
2 HAILI TEAL					
3 PIOPIO BEARS COED 10					
4 KEAUKAHA CUZINS COED 10 (2)					
5 KEAUKAHA CUZINS COED 8					
1-5	2-3	1-4	3-5	2-4	1-3
4-5	1-2	3-4	2-5		

COED 10 - SINGLE ELIMINATION

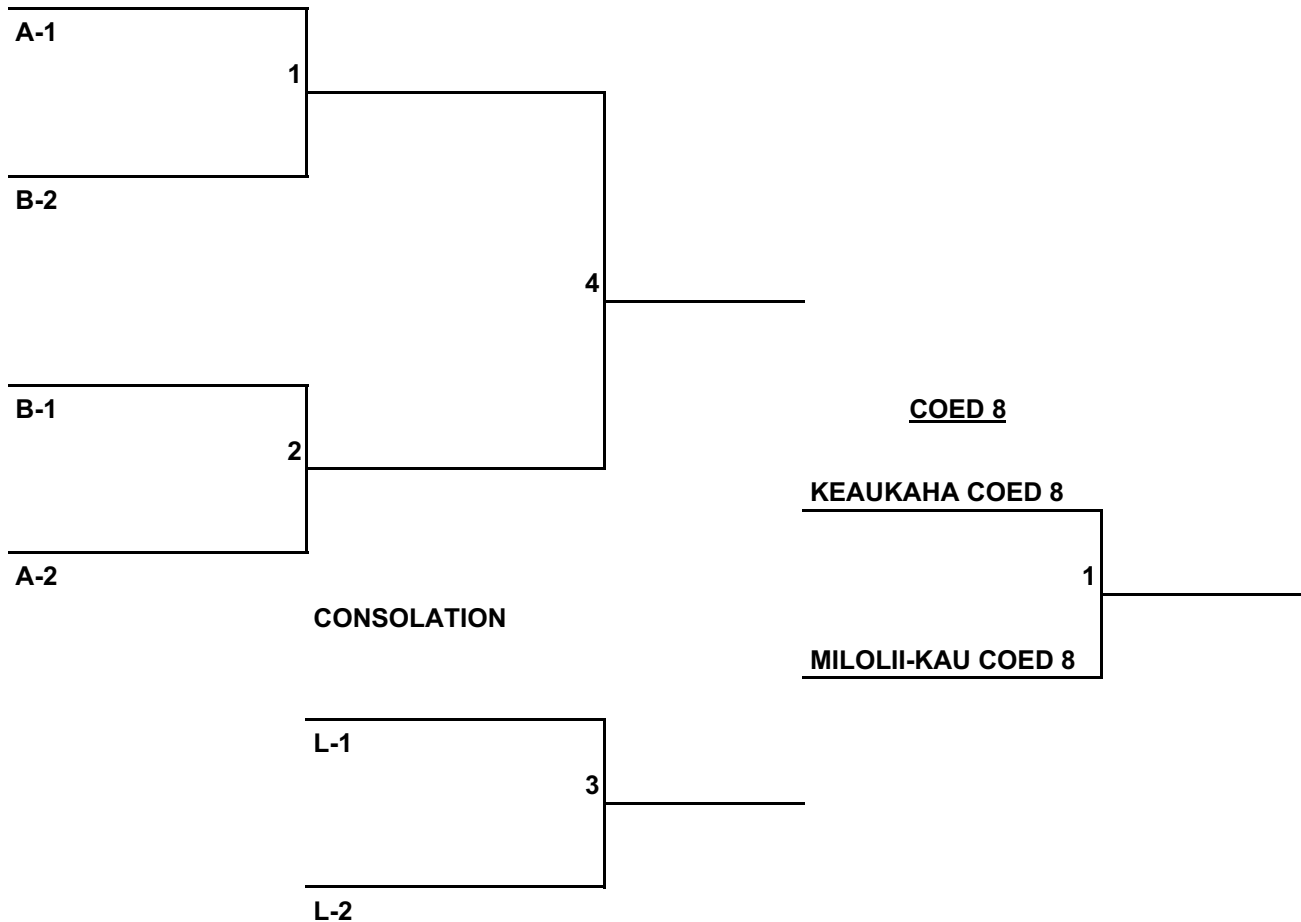

GIRLS 12 - ROUND ROBIN

Pool A				Won	Lost
1 KEAUKAHA CUZINS A					
2 HOOPA HAWAII					
3 PIOPIO BEARS 12s					
4 MAUI JRS VBC					
5 NAWAHI NA'AUAO					
1-5	2-3	1-4	3-5	2-4	1-3
4-5	1-2	3-4	2-5		

Pool B				Won	Lost
1 PANAWEWA HANO					
2 PIOPIO BEARS - YOSH					
3 KEAUKAHA CUZINS B					
4 MILOLII - KAU					
5 PURE ALOHA AMBASSADORS					
1-5	2-3	1-4	3-5	2-4	1-3
4-5	1-2	3-4	2-5		

GIRLS 12 - SINGLE ELIMINATION

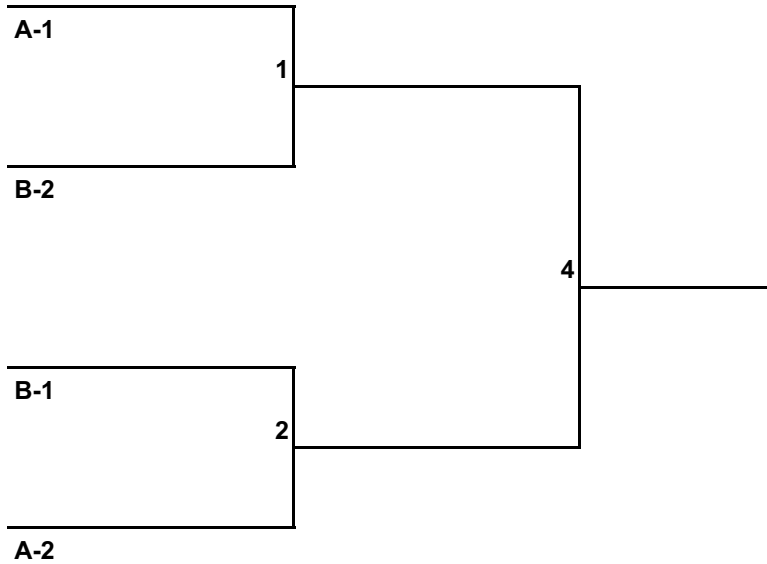

CONSOLATION

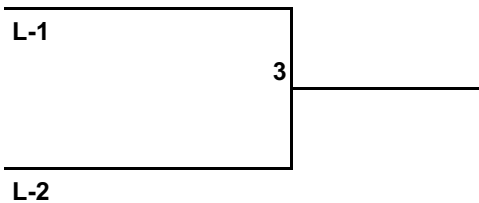

GIRLS 14 - ROUND ROBIN

Pool A				Won	Lost
1 PANAWEWA BLUE					
2 PIOPIO BEARS 14					
3 MAUI JRS VBC					
4 KEAUKAHA CUZINS 12'S					
5 NAWAHI - HANO HANO					
1-5	2-3	1-4	3-5	2-4	1-3
4-5	1-2	3-4	2-5		

Pool B				Won	Lost
1 HAILI JRS 14S					
2 KEAUKAHA CUZINS 14'S					
3 KA LIKO					
4 PANAWEWA ORANGE					
5 PURE ALOHA TEAL					
1-5	2-3	1-4	3-5	2-4	1-3
4-5	1-2	3-4	2-5		

Pool C				Won	Lost
1 PIOPIO BEARS - KUPA'AKAHI					
2 PURE ALOHA SILVER					
3 PA'ANI PONO					
4 KPVC					
5 HOOPA HAWAII					
1-5	2-3	1-4	3-5	2-4	1-3
4-5	1-2	3-4	2-5		

GIRLS 14 - SINGLE ELIMINATION

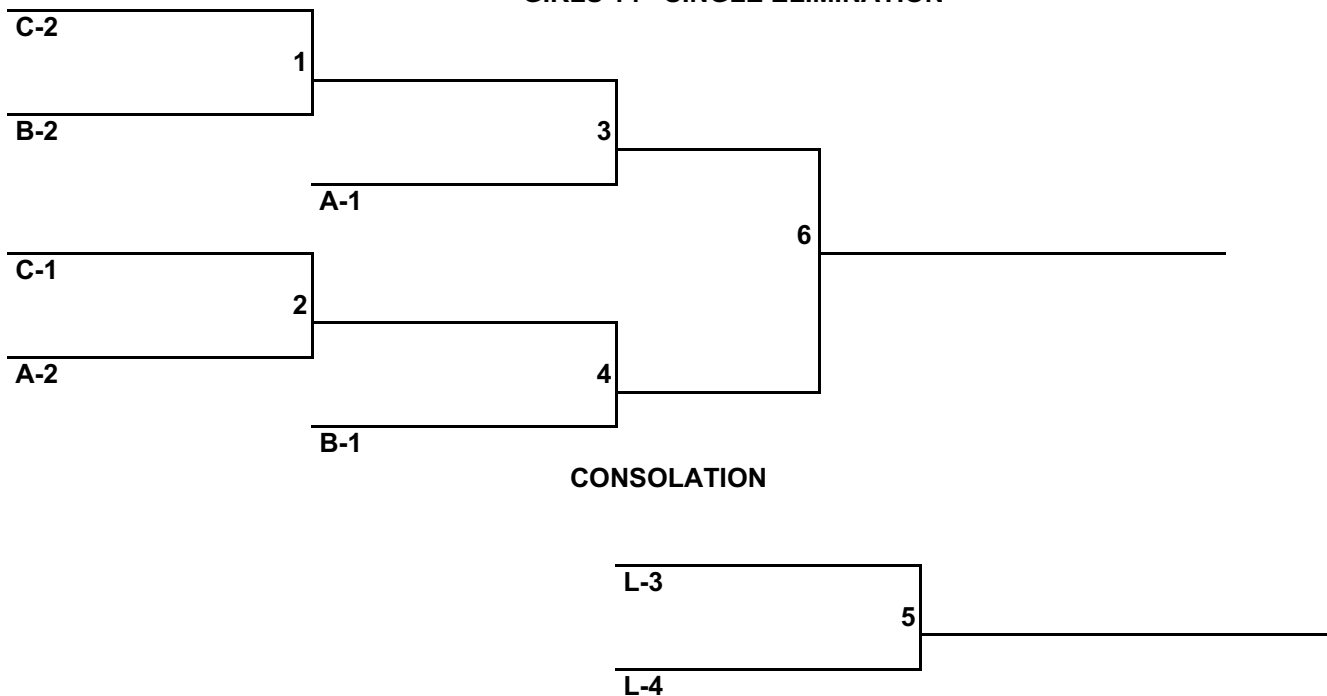

GIRLS 16 - ROUND ROBIN

Pool A				Won	Lost
1 HI INTENSITY					
2 KEAUKAHA CUZINS					
3 PILIPAA WHITE					
4 PANAWEA					
5 PURE ALOHA SILVER					
1-5	2-3	1-4	3-5	2-4	1-3
4-5	1-2	3-4	2-5		

Pool B				Won	Lost
1 PIOPIO BEARS					
2 PLIPAA BLACK					
3 MAUI JRS VBC					
4 ALL ATTITUDE					
5 LAWAKUA					
1-5	2-3	1-4	3-5	2-4	1-3
4-5	1-2	3-4	2-5		

GIRLS 16 - SINGLE ELIMINATION

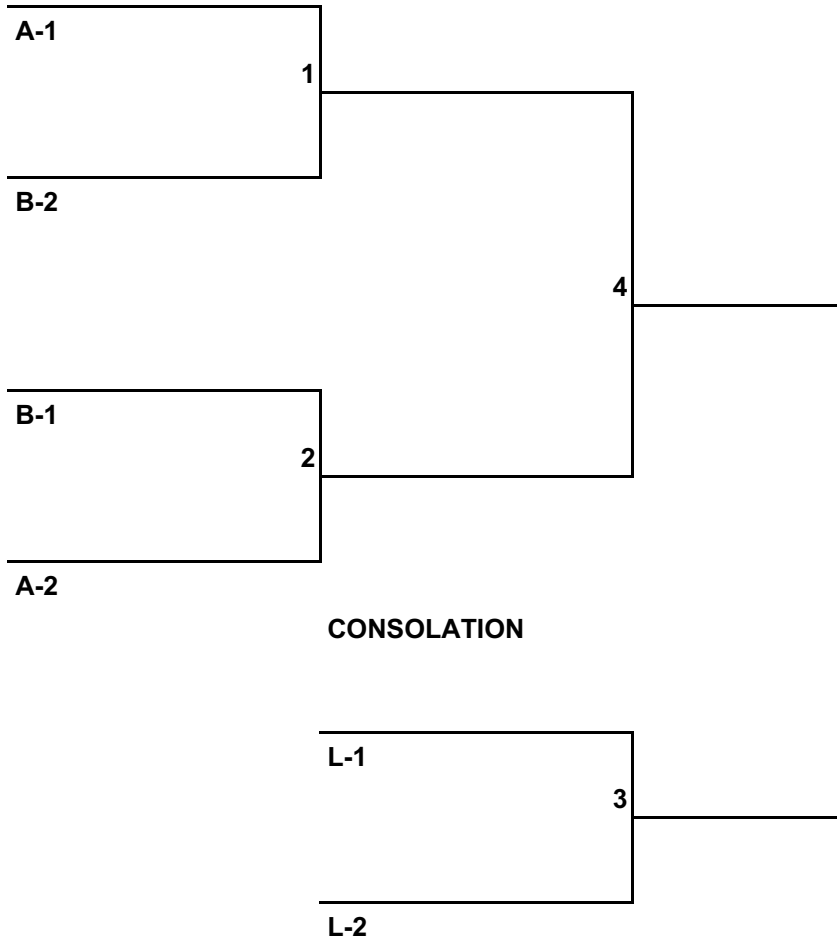

GIRLS 18 -ROUND-ROBIN

Pool A				Won	Lost
1 PIOPIO BEARS KU'IKAIKA					
2 KEAUKAHA CUZINS					
3 HAGGAN NEX GEN					
4 HAILI JRS PINK					
1-2	3-4	1-3	2-4	1-4	2-3

Pool B				Won	Lost
1 HAILI JRS TEAL					
2 HI INTENSITY					
3 MOLOKAI VOLLEYBALL					
4 POOKELA					
1-2	3-4	1-3	2-4	1-4	2-3

GIRLS 18 - SINGLE ELIMINATION

CHAMPIONSHIP BRACKET

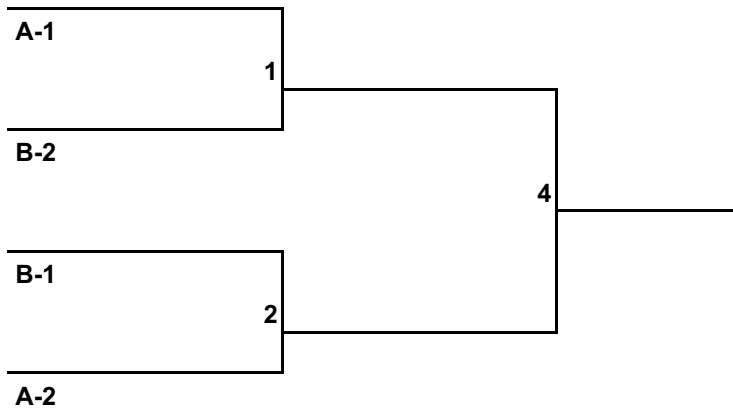

CONSOLATION

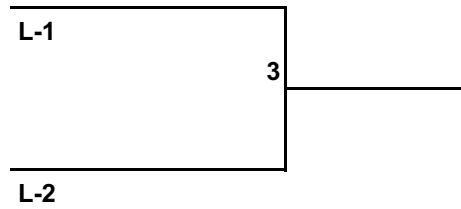

CONSOLATION BRACKET

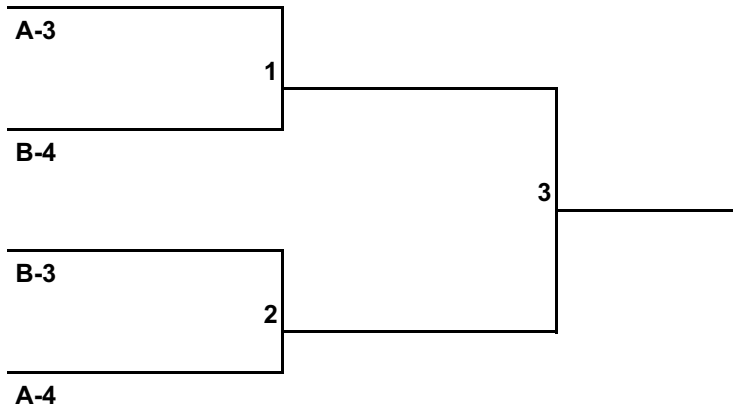

BOYS 12/14 - ROUND ROBIN

POOL A				WON	LOST
1 PILIPAA 14 A					
2 PURE ALOHA BLACK					
3 NAWAHI WIWOOLE 12s					
1-2	2-3	1-3	1-2	2-3	1-3

POOL B				WON	LOST
1 MAUI JRS VBC					
2 PILIPAA 14 B					
3 KEAUKAHA CUZINS 12s					
1-2	2-3	1-3	1-2	2-3	1-3

BOYS 12/14 - DOUBLE ELIMINATION

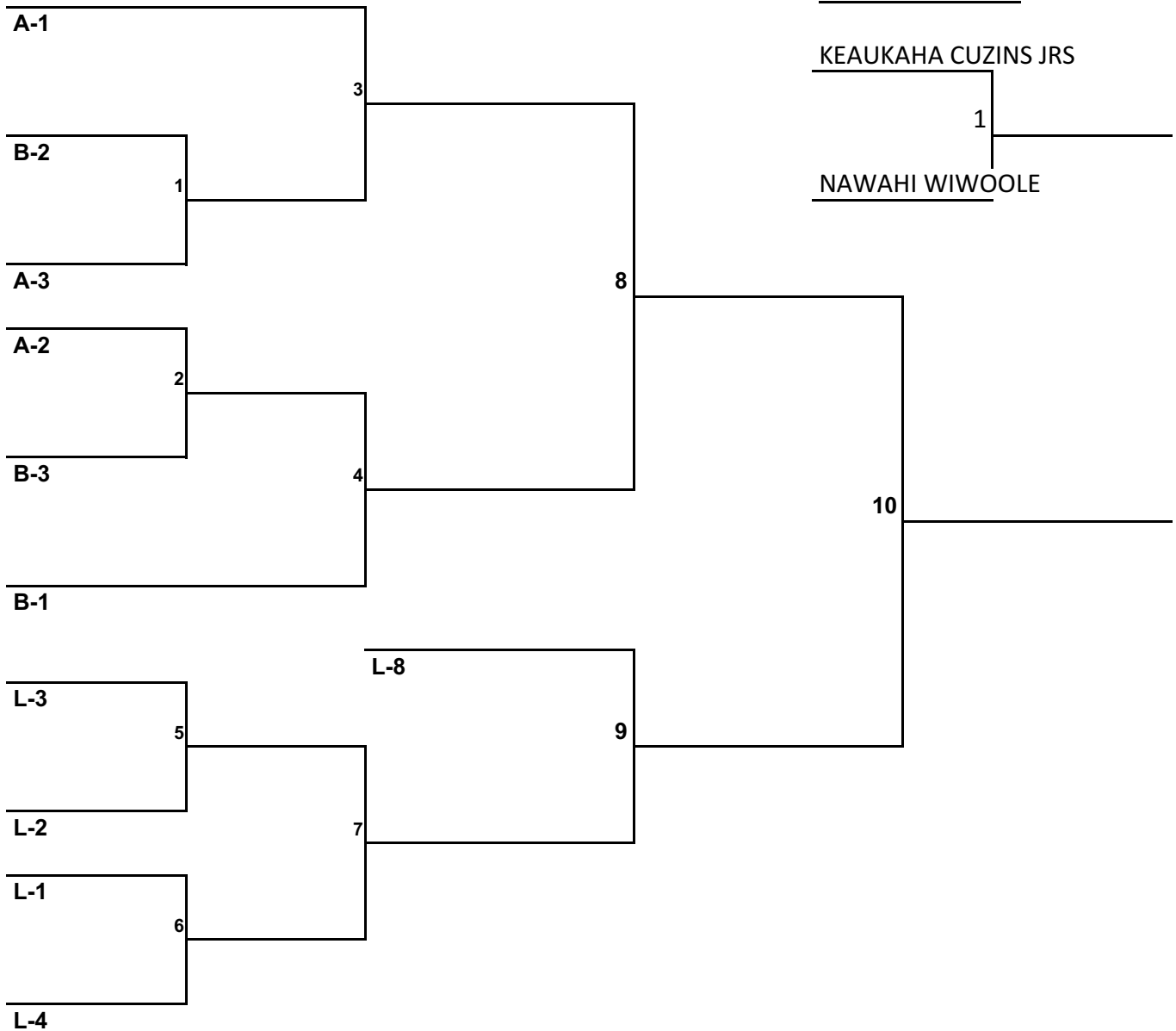

WOMEN B - ROUND ROBIN

Pool A				Won	Lost
1 HI INTENSITY-HILO					
2 ONE FUSION					
3 MOLOKAI VPC					
4 TEAM MAREEZ					
1-4	2-3	1-3	2-4	1-2	3-4

Pool B				Won	Lost
1 KORONA GIRLS					
2 PURE ALOHA VBC					
3 HAGGAN LE FEMME					
4 HAILI					
1-4	2-3	1-3	2-4	1-2	3-4

Pool C				Won	Lost
1 KEAUKAHA VBC					
2 MGVC - KIME KA LA					
3 FLEU					
4 LAST CALL! WOMEN					
1-4	2-3	1-3	2-4	1-2	3-4

Pool D				Won	Lost
1 ALL ATTITUDE (TITA)					
2 PANAEWA MAMAS					
3 PA'A PONO					
4 HAGGAN NEX GEN					
1-4	2-3	1-3	2-4	1-2	3-4

WOMEN B - SINGLE ELIMINATION

CHAMPIONSHIP BRACKET

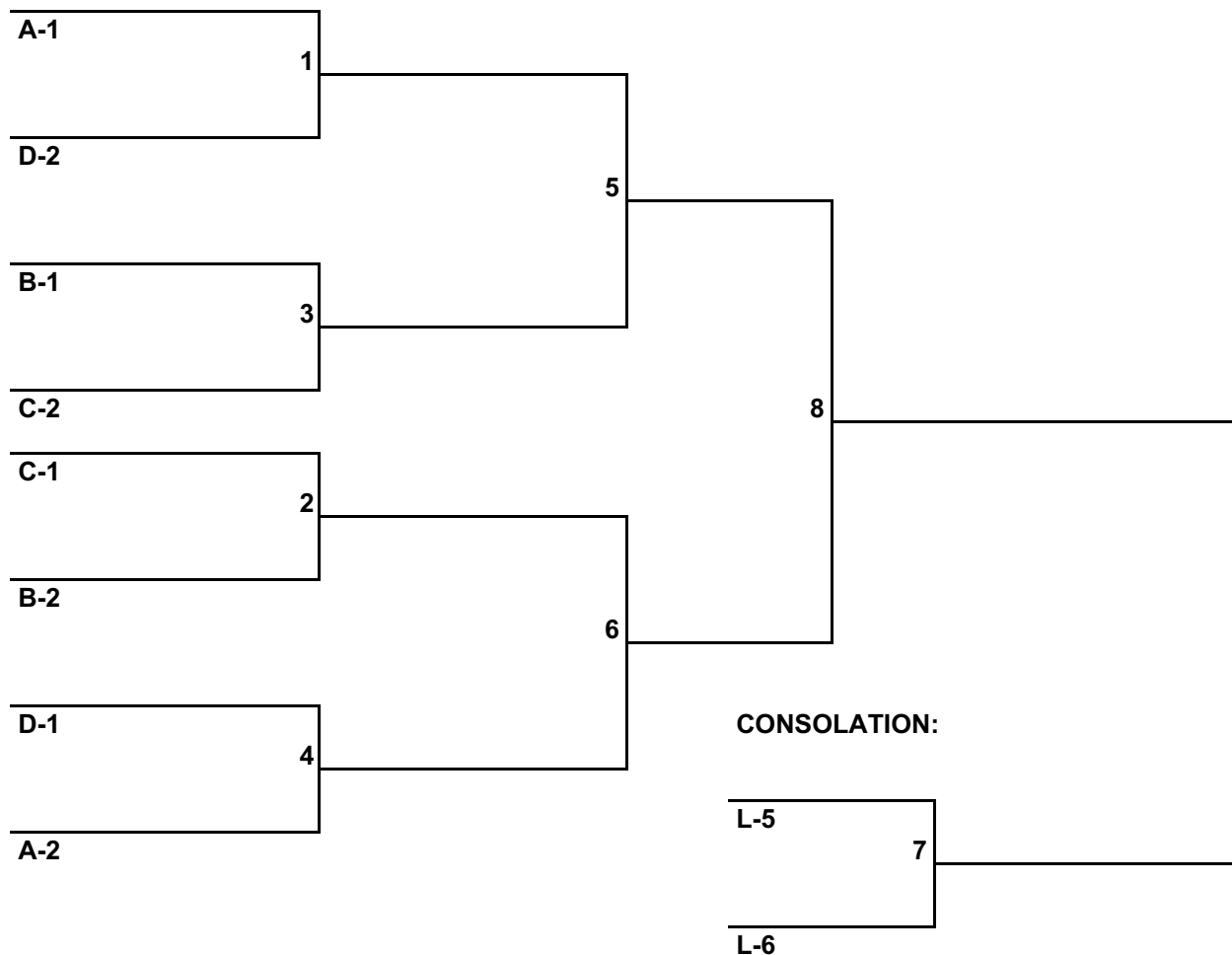

WOMEN B - SINGLE ELIMINATION

CONSOLATION BRACKET

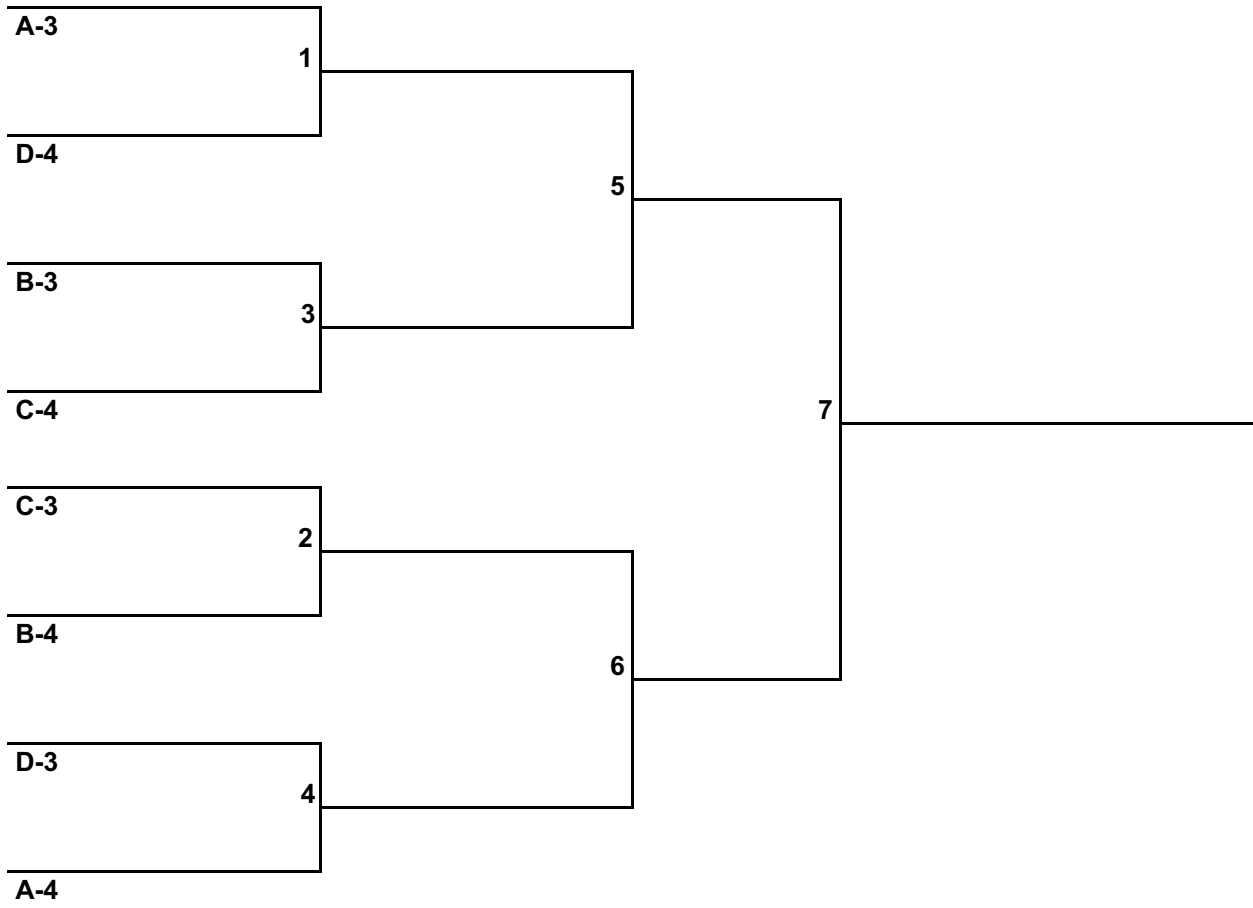

MEN B - ROUND ROBIN

Pool A				Won	Lost
1	ALL ATTITUDE				
2	TOLOUNA SAMOA				
3	HEMOLELE MASTERS				
4	PURE ALOHA BLACK				
1-2	3-4	1-3	2-4	1-4	2-3

Pool B				Won	Lost
1	IGDF				
2	ONE FUSION				
3	HEMOLELE				
4	SERVE & PASS				
1-2	3-4	1-3	2-4	1-4	2-3

Pool C				Won	Lost
1	PURE ALOHA TEAL				
2	KEAUKAHA VBC				
3	NO 'ANE'I				
4	PILIPAA 14s				
1-2	3-4	1-3	2-4	1-4	2-3

MEN B - SINGLE ELIMINATION

CHAMPIONSHIP BRACKET

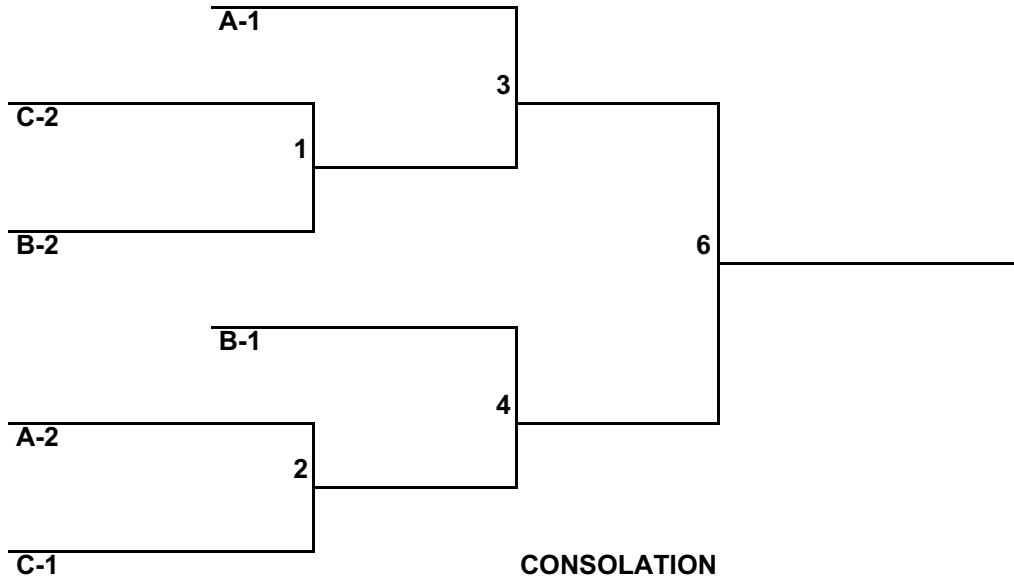

CONSOLATION

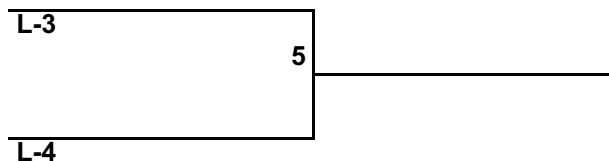

MEN B - SINGLE ELIMINATION

CONSOLATION BRACKET

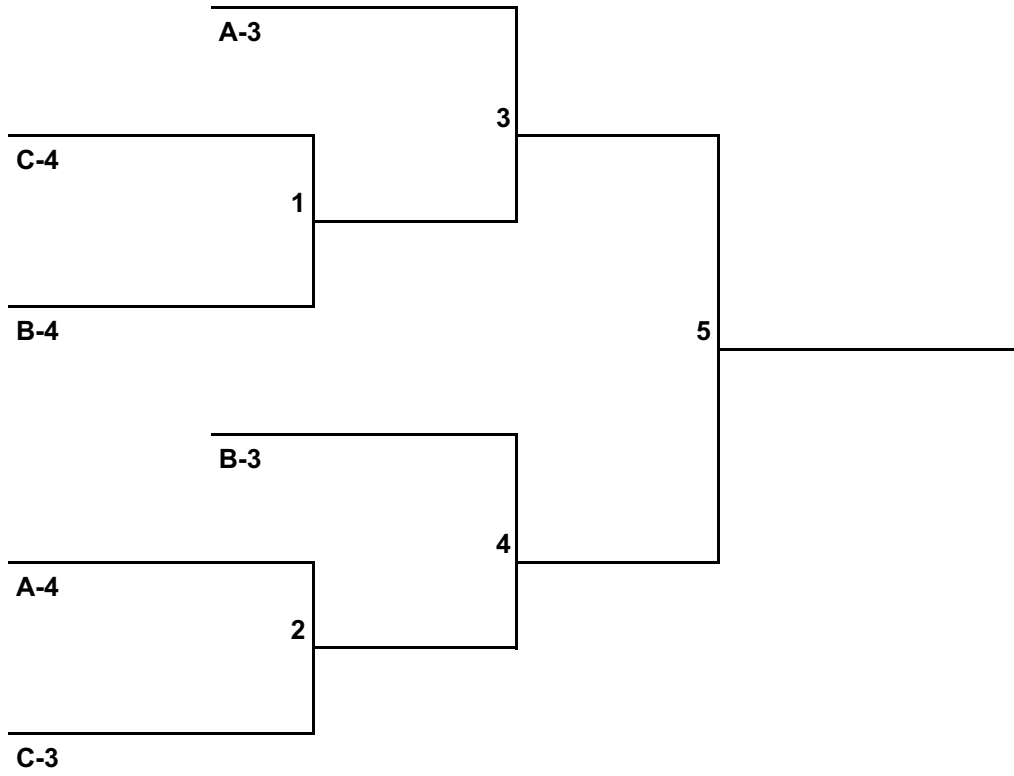

WA - ROUND ROBIN

Pool A				Won	Lost
1 KEAUKAHA CUZINS					
2 ALL INU					
3 KANPAI					
4 HOOPA HAWAII					
5 PURE ALOHA					
1-5	2-3	1-4	3-5	2-4	1-3
4-5	1-2	3-4	2-5		

Pool B				Won	Lost
1 HO'OKUI VBC					
2 ELEU					
3 KEAUKAHA VBC					
4 LAWAKUA					
5 ALL ATTITUDE					
1-5	2-3	1-4	3-5	2-4	1-3
4-5	1-2	3-4	2-5		

WA - SINGLE ELIMINATION

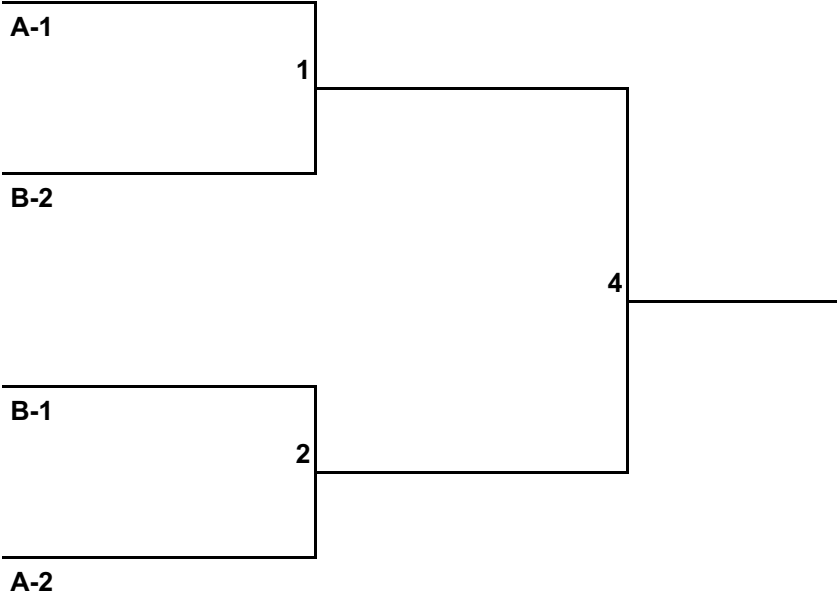

CONSOLATION

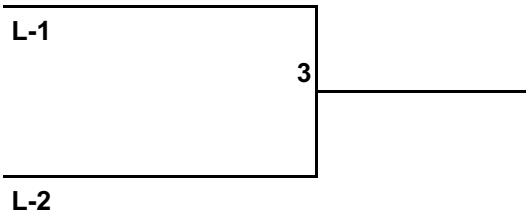

MA - ROUND ROBIN

Pool A				Won	Lost
1 SONS A					
2 ALL ATTITUDE - IVAN					
3 PURE ALOHA SILVER					
4 NP - BAD COMPANY - KAIMI					
5 PILIPAA 17s					
1-5	2-3	1-4	3-5	2-4	1-3
4-5	1-2	3-4	2-5		

Pool B				Won	Lost
1 NO PRESSURE - DA HOAZ					
2 PILIPAA 18s					
3 ALOHA DAYS					
4 ALL ATTITUDE - MAKANA					
5 PURE ALOHA TEAL					
1-5	2-3	1-4	3-5	2-4	1-3
4-5	1-2	3-4	2-5		

Pool C				Won	Lost
1 NP - BAD COMPANY - BRAD					
2 KEAUKAHA VBC					
3 HAWAIIAN STYLE					
4 BIG ISLAND BOYS					
5 DAUNTLESS					
1-5	2-3	1-4	3-5	2-4	1-3
4-5	1-2	3-4	2-5		

MA - SINGLE ELIMINATION

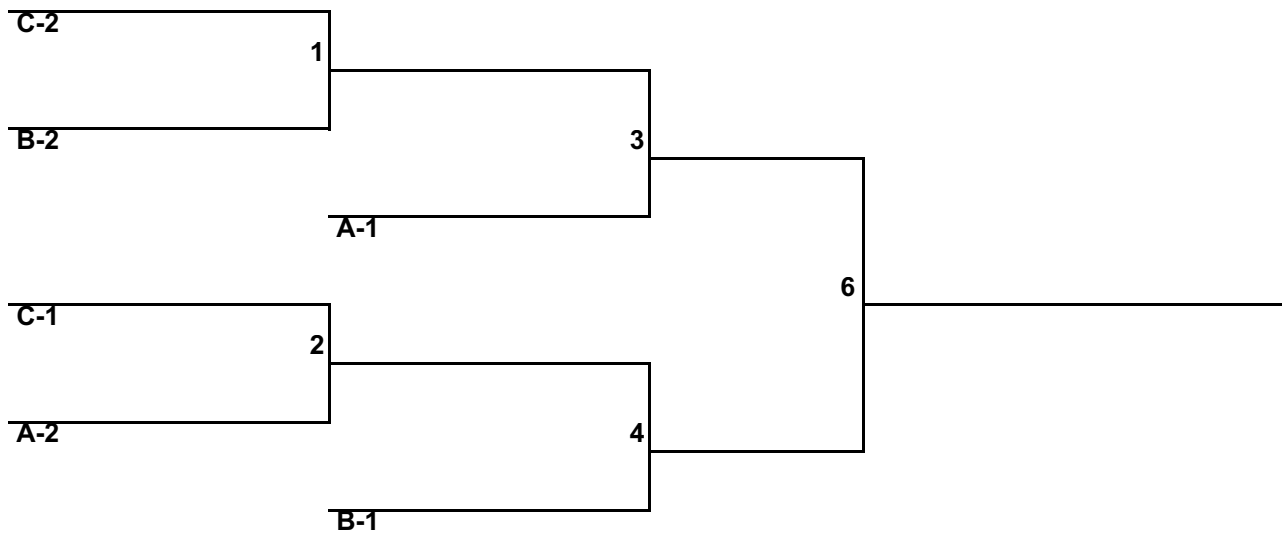

CONSOLATION

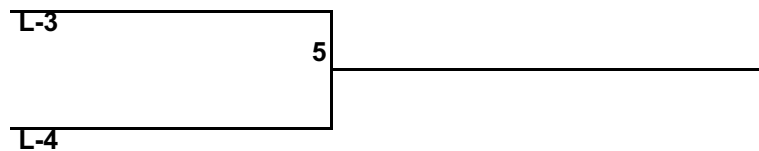

WAA - ROUND ROBIN

Pool A				Won	Lost
1 SAWAIIAN					
2 A MOTHERS PRAYER					
3 BRADDAHS					
4 HAILI JRS TEAL					
1-2	3-4	1-3	2-4	1-4	2-3

Pool B				Won	Lost
1 HI INTENSITY - OAHU					
2 HAWAIIAN STYLE					
3 HOOPA HAWAII					
4 LAWAKUA					
1-2	3-4	1-3	2-4	1-4	2-3

WAA - SINGLE ELIMINATION

CHAMPIONSHIP BRACKET

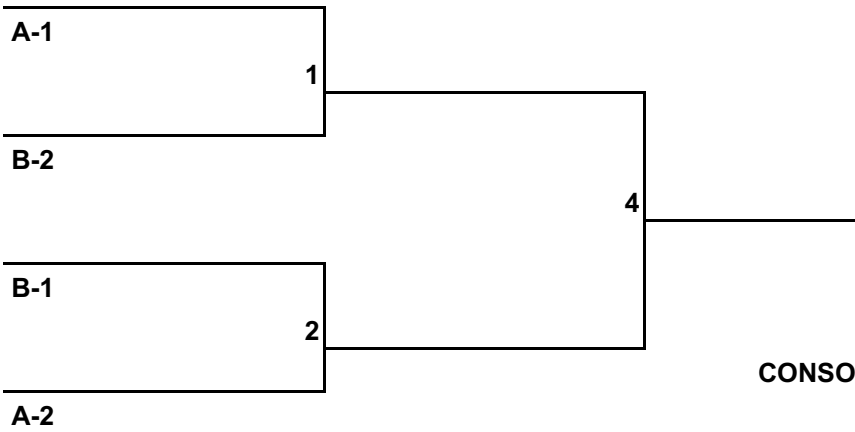

CONSOLATION

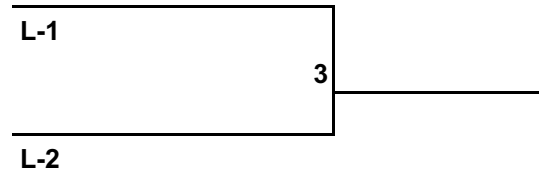

CONSOLATION BRACKET

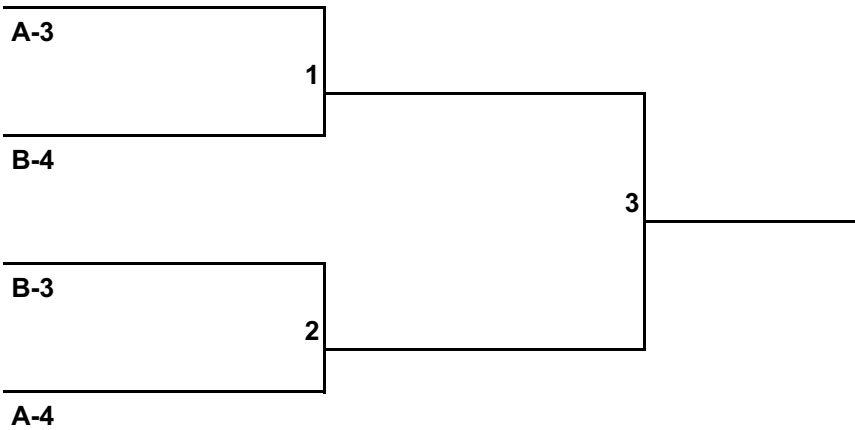

MEN AA - ROUND ROBIN

Pool A				Won	Lost
1 BIG ISLAND ROOTS					
2 TASI LE LOTO					
3 LIL BRADDAHS					
4 HI-BRED					
5 SONS					
6 KAILUA					
1-2	3-4	5-6	2-3	1-4	3-6
2-5	1-6	4-5	1-3	2-6	3-5
2-4	1-5	4-6			

MEN AA - SINGLE ELIMINATION

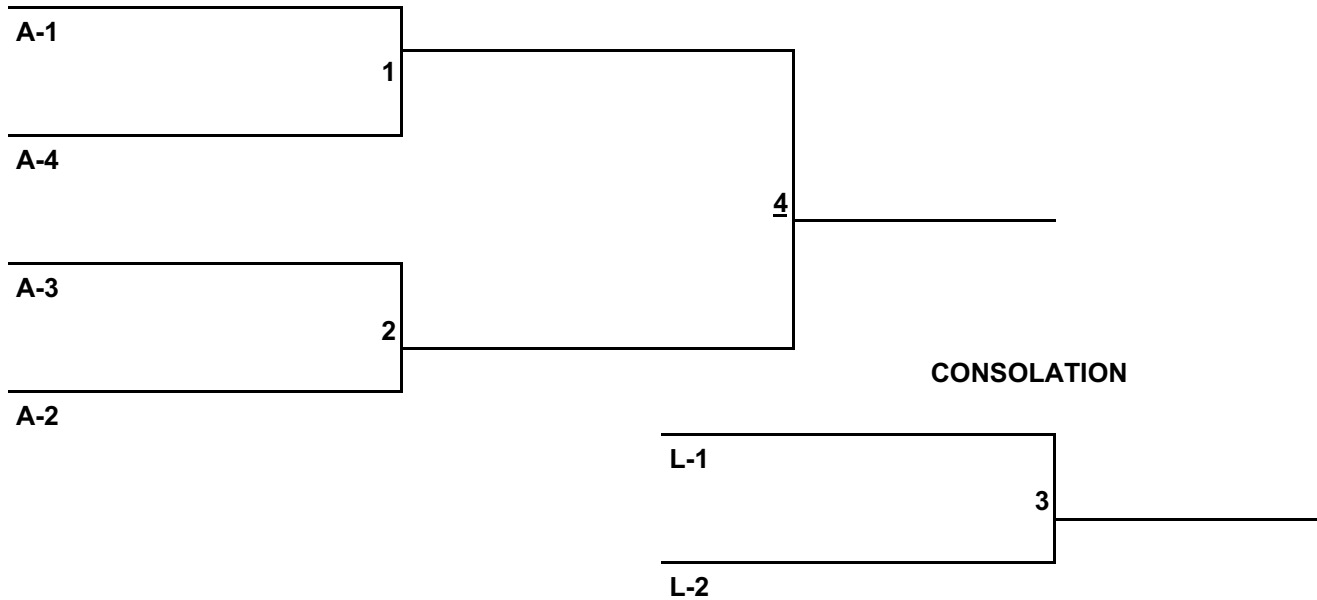

WOMEN MASTERS - ROUND ROBIN

Pool A				Won	Lost
1	HAILI MASTERS 30				
2	HAILI MASTERS 45				
3	PUAKENEKENE GOLD				
4	PUAKENEKENE YELLOW				
5	PUAKENEKENE WHITE				
1-5	2-3	1-4	3-5	2-4	1-3
4-5	1-2	3-4	2-5		

WOMEN MASTERS 30 - SINGLE ELIMINATION

HAILI MASTERS 30



WOMEN MASTERS 45- SINGLE ELIMINATION

HAILI MASTERS 45

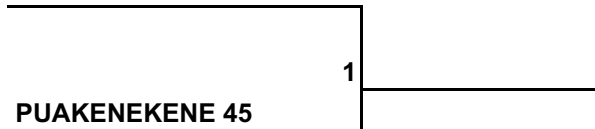

MEN MASTERS - SINGLE ELIMINATION

Pool A	Won	Lost
1 BIG ISLAND BOYS		
2 HEMOLELE		

BIG ISLAND BOYS

